

# INN650TA050AH

## 1. General description

650V GaN-on-Silicon Enhancement-mode Power Transistor in TOLL package

## 2. Features

- Enhancement mode transistor-Normally off power switch
- Ultra high switching frequency
- No reverse-recovery charge
- Low gate charge, low output charge
- Qualified for industrial applications according to JEDEC Standards
- ESD safeguard
- RoHS, Pb-free, REACH-compliant

## 3. Applications

- AC-DC converters
- DC-DC converters
- DC-AC converters
- High density power conversion
- High efficiency power conversion

## 4. Key performance parameters

**Table 1** Key performance parameters at  $T_j = 25\text{ }^\circ\text{C}$

Parameter	Value	Unit
$V_{DS,max}$	650	V
$R_{DS(on),max}$ @ $V_{GS} = 6\text{ V}$	50	m $\Omega$
$Q_{G,typ}$ @ $V_{DS} = 400\text{ V}$	12.5	nC
$I_{D,pulse}$	84	A
$Q_{OSS}$ @ $V_{DS} = 400\text{ V}$	150	nC
$Q_{rr}$ @ $V_{DS} = 400\text{ V}$	0	nC

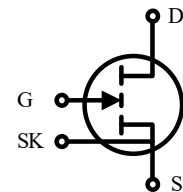
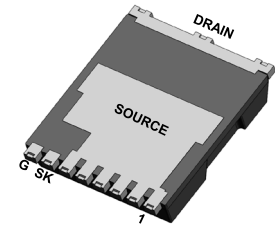
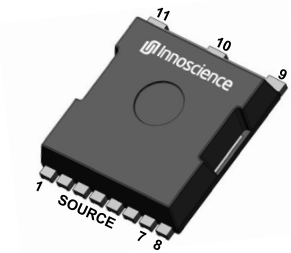
## 5. Pin information

**Table 2** Pin information

Gate	Drain	Kelvin Source	Source
8	9, 10, 11	7	1, 2, 3, 4, 5, 6

**Table 3** Ordering information

Type/Ordering Code	Package	Product Code
INN650TA050AH	TOLL	65TA050A



**Table of contents**

<b>1. General description .....</b>	<b>1</b>
<b>2. Features .....</b>	<b>1</b>
<b>3. Applications.....</b>	<b>1</b>
<b>4. Key performance parameters.....</b>	<b>1</b>
<b>5. Pin information .....</b>	<b>1</b>
<b>6. Maximum ratings.....</b>	<b>3</b>
<b>7. Thermal characteristics.....</b>	<b>4</b>
<b>8. Electric characteristics .....</b>	<b>5</b>
<b>9. Electric characteristics diagrams .....</b>	<b>7</b>
<b>10.Package outlines .....</b>	<b>13</b>
<b>11.Reel information.....</b>	<b>14</b>
<b>12.Recommended PCB footprint .....</b>	<b>15</b>
<b>13.Revision history .....</b>	<b>16</b>

## 6. Maximum ratings

at  $T_j = 25\text{ °C}$  unless otherwise specified

Exceeding the maximum ratings may destroy the device. For further information, contact Innoscience sales office

**Table 4** Maximum ratings

Parameter	Symbol	Values	Unit	Note/Test Condition
Drain source voltage	$V_{DS,max}$	650	V	$V_{GS} = 0\text{ V}$ , $T_j = -55\text{ °C}$ to $150\text{ °C}$
Drain source voltage transient <sup>1</sup>	$V_{DS,transient}$	800	V	$V_{GS} = 0\text{ V}$
Drain source voltage, pulsed <sup>2</sup>	$V_{DS,pulse}$	750	V	$T_j = 25\text{ °C}$ ; total time < 10 h
				$T_j = 125\text{ °C}$ ; total time < 1 h
Continuous current, drain source	$I_D$	40	A	$T_c = 25\text{ °C}$
Continuous current, drain source	$I_D$	26	A	$T_c = 125\text{ °C}$
Pulsed current, drain source <sup>3</sup>	$I_{D,pulse}$	84	A	$T_c = 25\text{ °C}$ ; $V_G = 6\text{ V}$ ; $V_{DS} = 400\text{ V}$ ; $t_{PULSE} = 10\text{ }\mu\text{s}$
Pulsed current, drain source <sup>3</sup>	$I_{D,pulse}$	43	A	$T_c = 125\text{ °C}$ ; $V_G = 6\text{ V}$ ; $V_{DS} = 400\text{ V}$ ; $t_{PULSE} = 10\text{ }\mu\text{s}$
Gate source voltage, continuous	$V_{GS}$	-6 to +7	V	$T_j = -55\text{ °C}$ to $150\text{ °C}$
Gate source voltage, pulsed	$V_{GS,pulse}$	-20 to +10	V	$T_j = -55\text{ °C}$ to $150\text{ °C}$ ; $t_{PULSE} = 10\text{ ns}$ , $f = 100\text{ kHz}$ ; open drain
Power dissipation	$P_{tot}$	357	W	$T_c = 25\text{ °C}$
Operating temperature	$T_j$	-55 to +150	°C	
Storage temperature	$T_{stg}$	-55 to +150	°C	

1  $V_{DS,transient}$  is intended for non-repetitive events,  $t_{PULSE} < 200\text{ }\mu\text{s}$

2  $V_{DS,pulse}$  is intended for repetitive pulse,  $t_{PULSE} < 100\text{ ns}$

3 Limit was extracted from characterization test, not measured during production

## 7. Thermal characteristics

**Table 5 Thermal characteristics**

Parameter	Symbol	Values	Unit	Note/Test Condition
Thermal Resistance Junction to ambient	$R_{thJA}$	49.32	°C/W	
Thermal resistance, junction-case (bottom)	$R_{thJC}$	0.35	°C/W	
Maximum reflow soldering temperature	$T_{sold}$	260	°C	MSL3

## 8. Electric characteristics

 at  $T_j = 25\text{ °C}$ , unless specified otherwise

**Table 6 Static characteristics**

Parameter	Symbol	Values			Unit	Note/Test Condition
		Min.	Typ.	Max.		
Gate threshold voltage	$V_{GS(th)}$	1.2	1.7	2.5	V	$I_D = 61.9\text{ mA}; V_{DS} = V_{GS}; T_j = 25\text{ °C}$
		-	1.6	-		$I_D = 61.9\text{ mA}; V_{DS} = V_{GS}; T_j = 150\text{ °C}$
Drain-source leakage current	$I_{DSS}$	-	0.75	75	$\mu\text{A}$	$V_{DS} = 650\text{ V}; V_{GS} = 0\text{ V}; T_j = 25\text{ °C}$
		-	9	-		$V_{DS} = 650\text{ V}; V_{GS} = 0\text{ V}; T_j = 150\text{ °C}$
Gate-source leakage current	$I_{GSS}$	-	180	-	$\mu\text{A}$	$V_{GS} = 6\text{ V}; V_{DS} = 0\text{ V}; T_j = 25\text{ °C}$
Drain-source on-state resistance	$R_{DS(on)}$	-	38	50	m $\Omega$	$V_{GS} = 6\text{ V}; I_D = 16\text{ A}; T_j = 25\text{ °C}$
		-	87	-		$V_{GS} = 6\text{ V}; I_D = 16\text{ A}; T_j = 150\text{ °C}$
Gate resistance	$R_G$	-	1.5	-	$\Omega$	$f = 5\text{ MHz}; \text{open drain}$

**Table 7 Dynamic characteristics**

Parameter	Symbol	Values			Unit	Note/Test Condition
		Min.	Typ.	Max.		
Input capacitance	$C_{iss}$	-	450	-	pF	$V_{GS} = 0\text{ V}; V_{DS} = 400\text{ V}; f = 100\text{ kHz}$
Output capacitance	$C_{oss}$	-	208	-	pF	$V_{GS} = 0\text{ V}; V_{DS} = 400\text{ V}; f = 100\text{ kHz}$
Reverse transfer Capacitance	$C_{rss}$	-	2.0	-	pF	$V_{GS} = 0\text{ V}; V_{DS} = 400\text{ V}; f = 100\text{ kHz}$
Effective output capacitance, energy related <sup>1</sup>	$C_{o(er)}$	-	285	-	pF	$V_{GS} = 0\text{ V}; V_{DS} = 0\text{ to }400\text{ V}$
Effective output capacitance, time related <sup>2</sup>	$C_{o(tr)}$	-	370	-	pF	$V_{GS} = 0\text{ V}; V_{DS} = 0\text{ to }400\text{ V}$
Output charge	$Q_{OSS}$	-	150	-	nC	$V_{GS} = 0\text{ V}; V_{DS} = 0\text{ to }400\text{ V}$
Turn-on delay time	$t_{d(on)}$	-	21	-	ns	$V_{DS} = 400\text{ V}; I_D = 32\text{ A}; V_{GS} = 6\text{ V}; R_{on} = 10\text{ }\Omega; R_{off} = 2\text{ }\Omega$
Turn-off delay time	$t_{d(off)}$	-	8	-	ns	
Rise time	$t_r$	-	10	-	ns	
Fall time	$t_f$	-	7	-	ns	

 1.  $C_{o(er)}$  is the fixed capacitance that gives the same stored energy as  $C_{OSS}$  while  $V_{DS}$  is rising from 0 to 400 V

 2.  $C_{o(tr)}$  is the fixed capacitance that gives the same charging time as  $C_{OSS}$  while  $V_{DS}$  is rising from 0 to 400 V

**Table 8 Gate charge characteristics**

Parameter	Symbol	Values			Unit	Note/Test Condition
		Min.	Typ.	Max.		
Gate charge	$Q_G$	-	12.5	-	nC	$V_{GS} = 0$ to 6 V; $V_{DS} = 400$ V; $I_D = 16$ A
Gate-source charge	$Q_{GS}$	-	1.0	-	nC	
Gate-drain charge	$Q_{GD}$	-	5.0	-	nC	
Gate Plateau Voltage	$V_{Plat}$	-	2.2	-	V	$V_{DS} = 400$ V; $I_D = 16$ A

**Table 9 Reverse conduction characteristics**

Parameter	Symbol	Values			Unit	Note/Test Condition
		Min.	Typ.	Max.		
Source-Drain reverse voltage	$V_{SD}$	-	2.5	-	V	$V_{GS} = 0$ V; $I_S = 16$ A
Pulsed current, reverse	$I_{S,pulse}$	-	-	135	A	$V_{GS} = 6$ V; $t_{PULSE} = 10$ $\mu$ s
Reverse recovery charge	$Q_{rr}$	-	0	-	nC	$I_S = 16$ A; $V_{SD} = 400$ V; $di/dt = 1$ kA/ $\mu$ s
Reverse recovery time	$t_{rr}$	-	0	-	ns	
Peak reverse recovery current	$I_{rrm}$	-	0	-	A	

## 9. Electric characteristics diagrams

at  $T_j = 25\text{ }^\circ\text{C}$ , unless specified otherwise

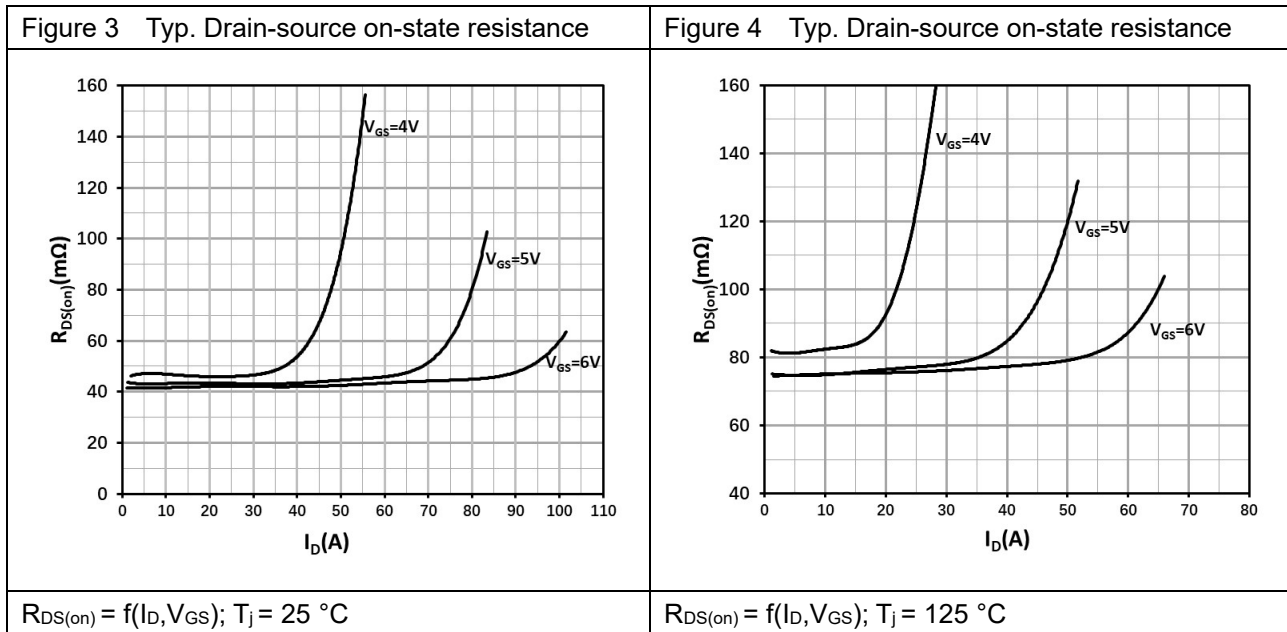
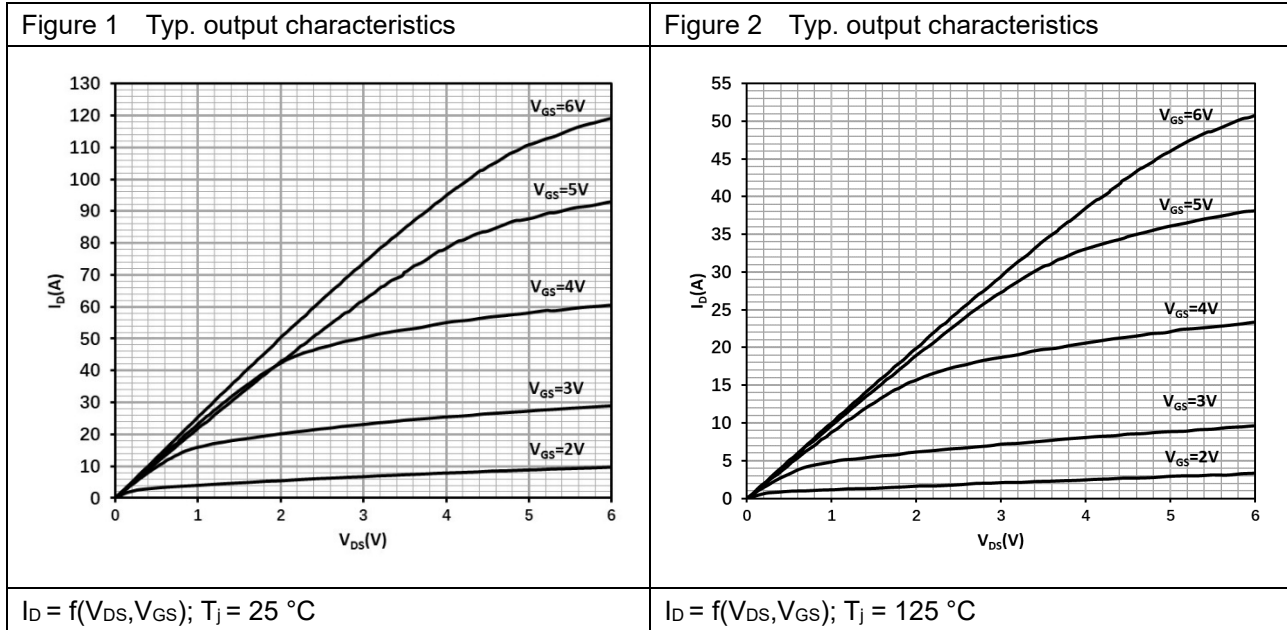
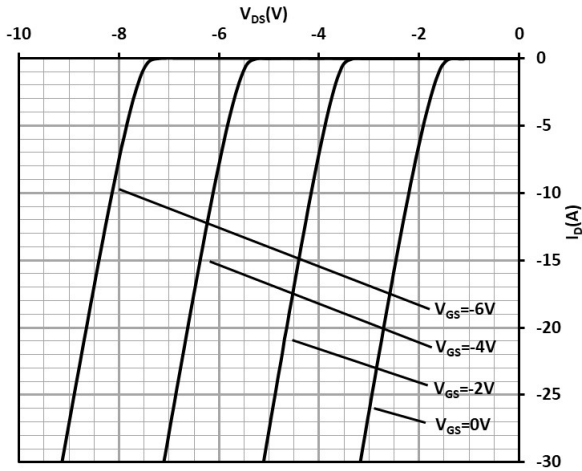
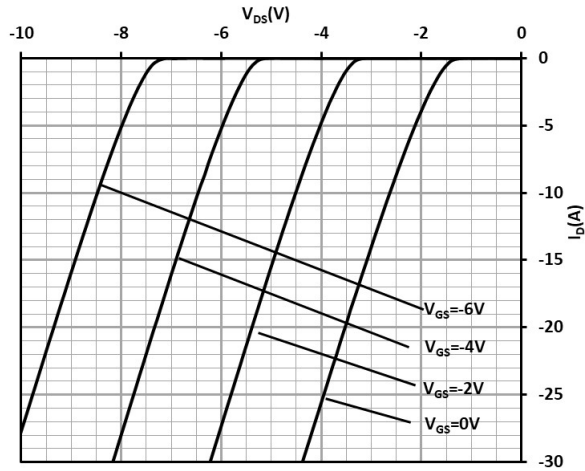


Figure 5 Typ. channel reverse characteristics



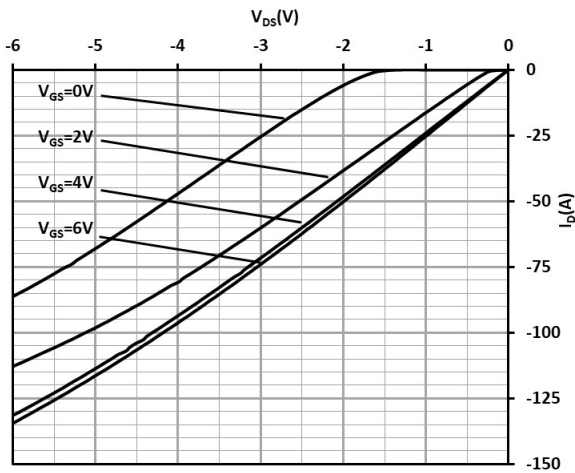
$I_D = f(V_{DS}, V_{GS}); T_j = 25\text{ °C}$

Figure 6 Typ. channel reverse characteristics



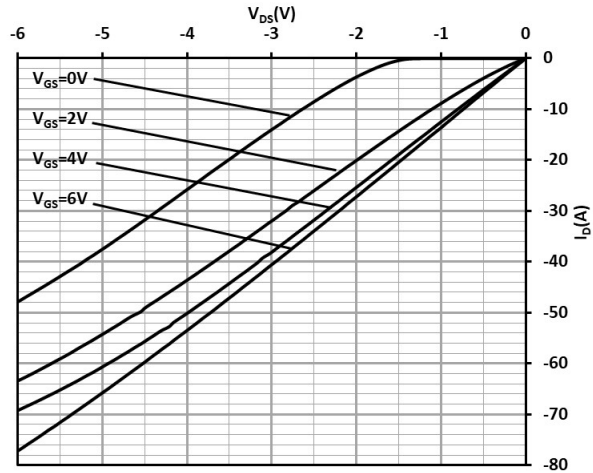
$I_D = f(V_{DS}, V_{GS}); T_j = 125\text{ °C}$

Figure 7 Typ. channel reverse characteristics



$I_D = f(V_{DS}, V_{GS}); T_j = 25\text{ °C}$

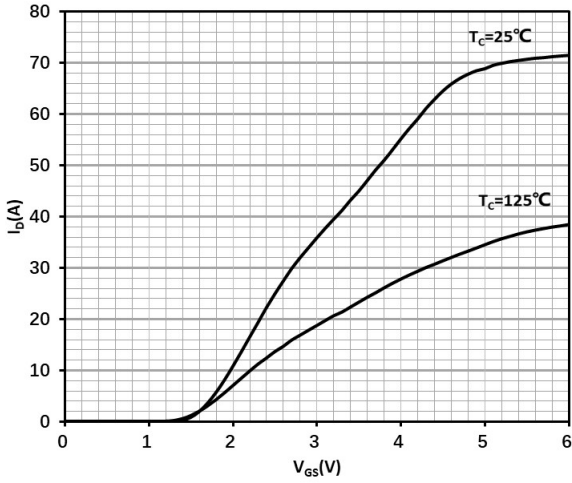
Figure 8 Typ. channel reverse characteristics



$I_D = f(V_{DS}, V_{GS}); T_j = 125\text{ °C}$

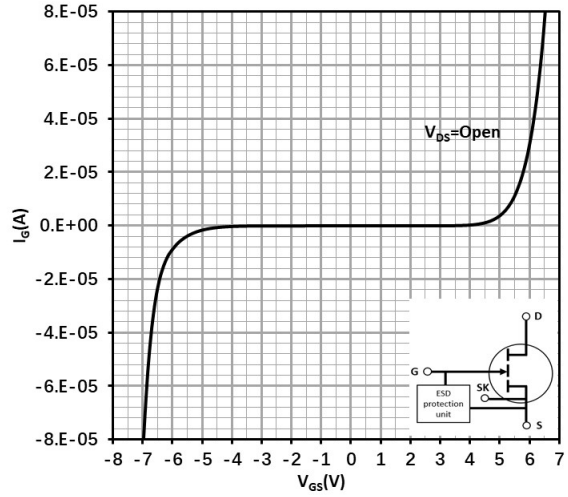


Figure 9 Typ. transfer characteristics



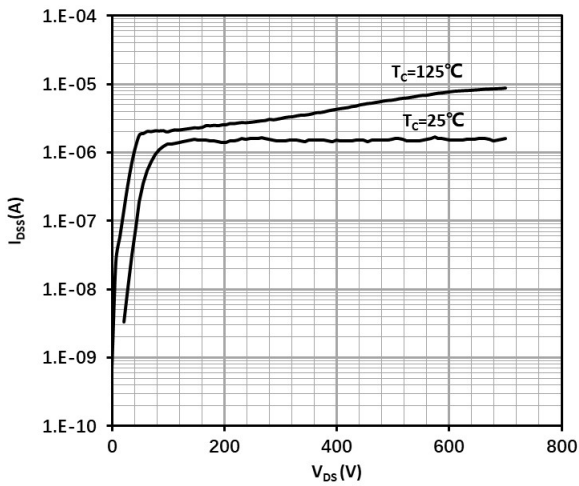
$I_D = f(V_{GS}); V_{DS} = 3\text{ V}$

Figure 10 Typ. Gate-to-Source leakage



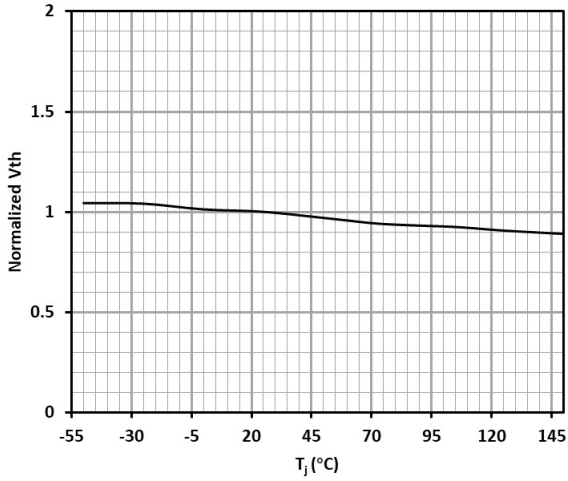
$I_G = f(V_{GS}); I_G$  reverse turn on by ESD unit

Figure 11 Drain-source leakage characteristics



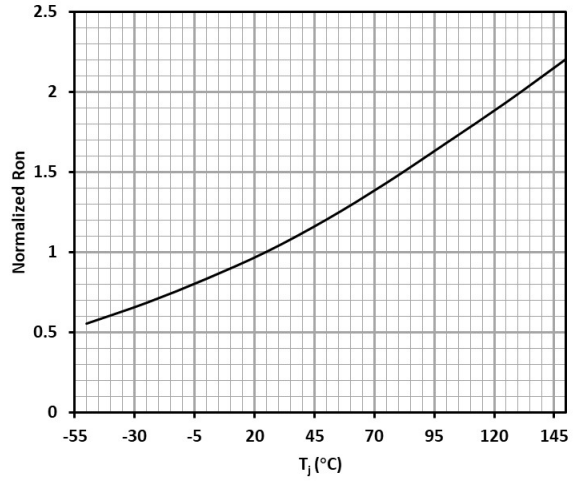
$I_{DSS} = f(V_{DS}); V_{GS} = 0\text{ V}$

Figure 12 Gate threshold voltage



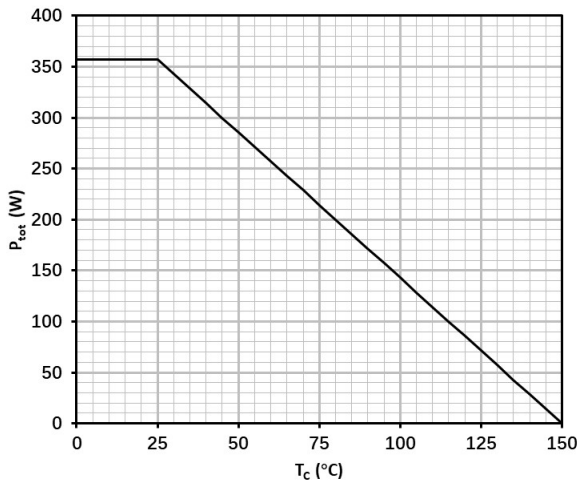
$V_{TH} = f(T_j); V_{GS} = V_{DS}; I_D = 61.9 \text{ mA}$

Figure 13 Drain-source on-state resistance



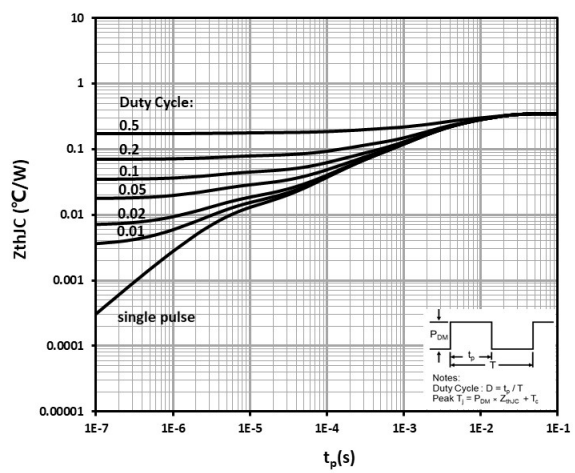
$R_{DS(on)} = f(T_j); I_D = 16 \text{ A}; V_{GS}=6\text{V}$

Figure 14 Power dissipation



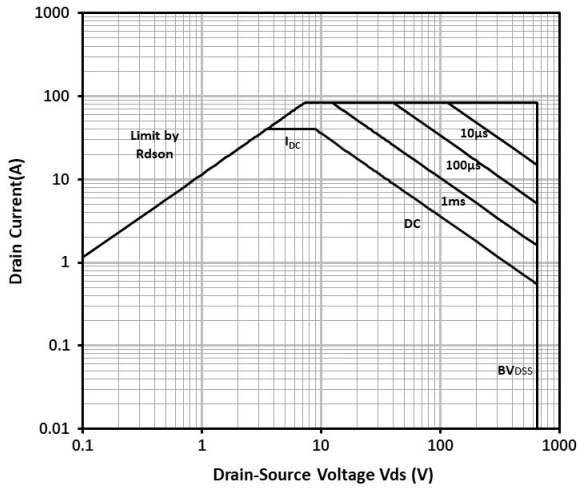
$P_{tot} = f(T_c)$

Figure 15 Max.transient thermal impedance



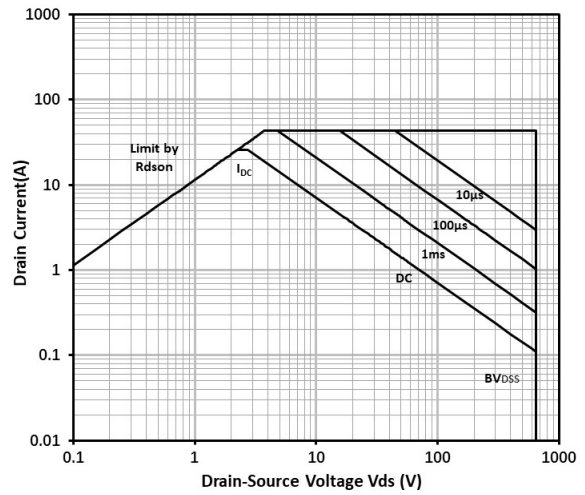
$Z_{thJC} = f(t_p, D)$

Figure 16 Safe operating area



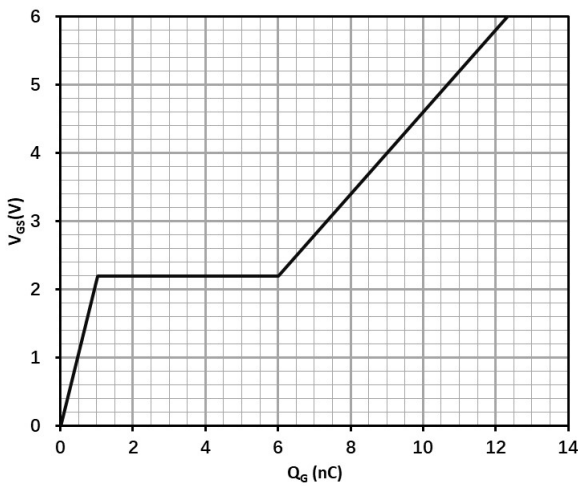
$I_D = f(V_{DS}); T_C = 25\text{ }^\circ\text{C}$

Figure 17 Safe operating area



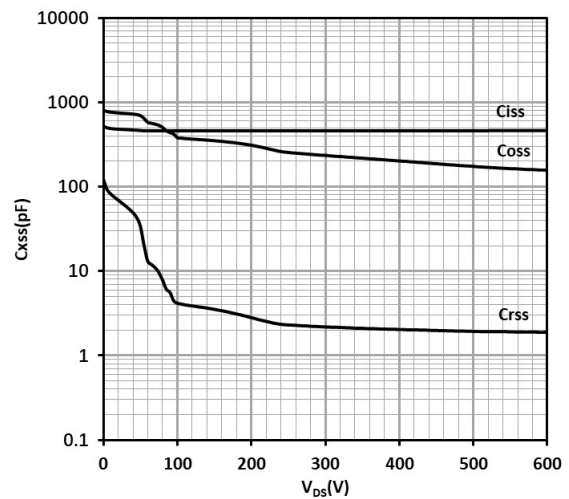
$I_D = f(V_{DS}); T_C = 125\text{ }^\circ\text{C}$

Figure 18 Typ. gate charge



$V_{GS} = f(Q_G); V_{DCLINK} = 400\text{ V}; I_D = 16\text{ A}$

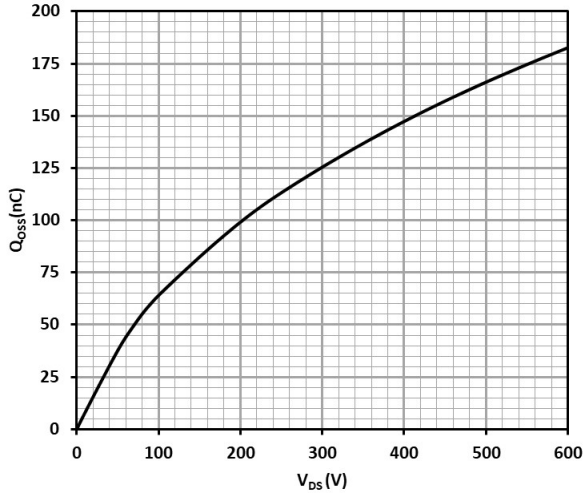
Figure 19 Typ. capacitances



$C_{XSS} = f(V_{DS}); \text{Freq.} = 100\text{ kHz}$

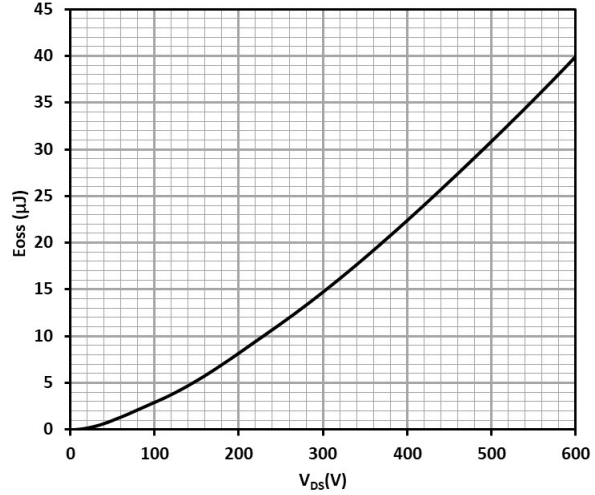
- SOA Curve is calculated with reference to the thermal resistance simulation value

Figure 20 Typ. output charge



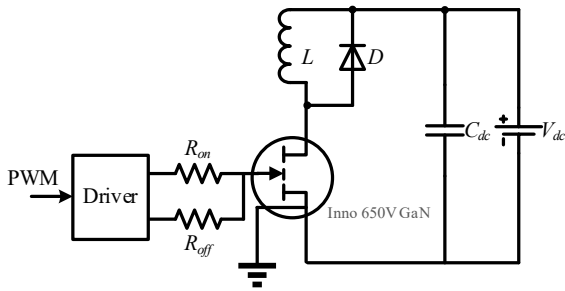
$Q_{oss} = f(V_{DS})$ ; Freq. = 100 kHz

Figure 21 Typ. Coss stored Energy



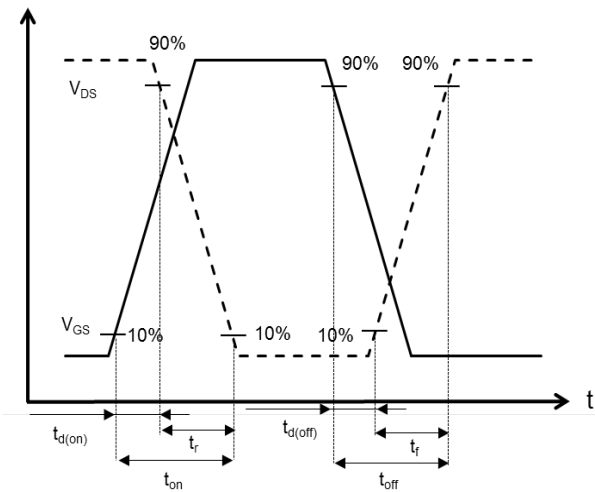
$E_{oss} = f(V_{DS})$ ; Freq. = 100 kHz

Figure 22 Typ. Switching times with inductive load

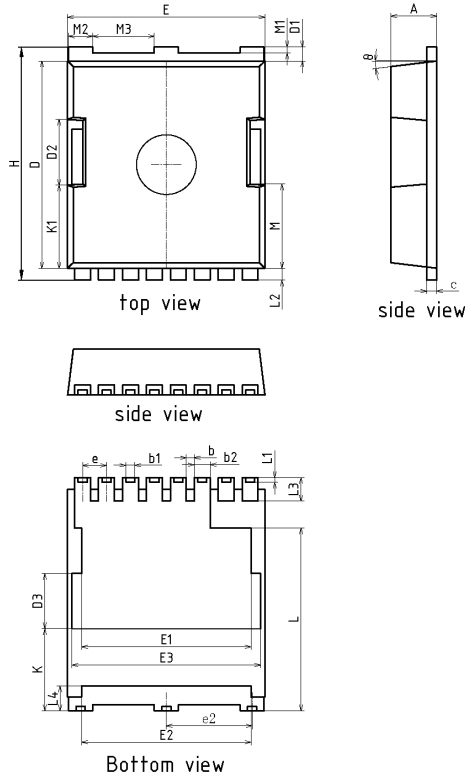


$V_{DS} = 400\text{ V}$ ,  $I_D = 32\text{ A}$ ,  $V_{GS} = 6\text{ V}$ ,  
 $R_{on} = 10\ \Omega$ ,  $R_{off} = 2\ \Omega$

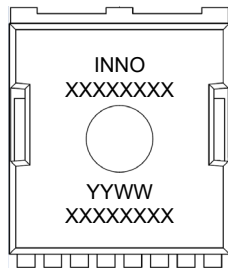
Figure 23 Typ. Switching times waveform



### 10. Package outlines



SYMBOL	MILLIMETER		
	MIN	NOM	MAX
A	2.15	2.30	2.45
b	0.30	0.40	0.50
b1	0.31	0.43	0.55
b2	0.65	0.80	0.90
c	0.40	0.50	0.60
D	10.18	10.38	10.58
D1	0.50	0.70	0.90
D2	3.30REF		
D3	2.77REF		
E	9.70	9.90	10.10
E1	8.50REF		
E2	8.50REF		
E3	9.46REF		
e	1.10	1.20	1.30
H	11.48	11.68	11.88
K	4.08REF		
K1	4.18REF		
L	9.13REF		
L1	0.23REF		
L2	0.50	0.60	0.70
L3	1.00	1.20	1.40
L4	1.00	1.20	1.40
M	4.18REF		
M1	0.26REF		
M2	1.10	1.20	1.30
M3	3.10REF		
Θ	10.00REF		
e2	4.20	4.30	4.40

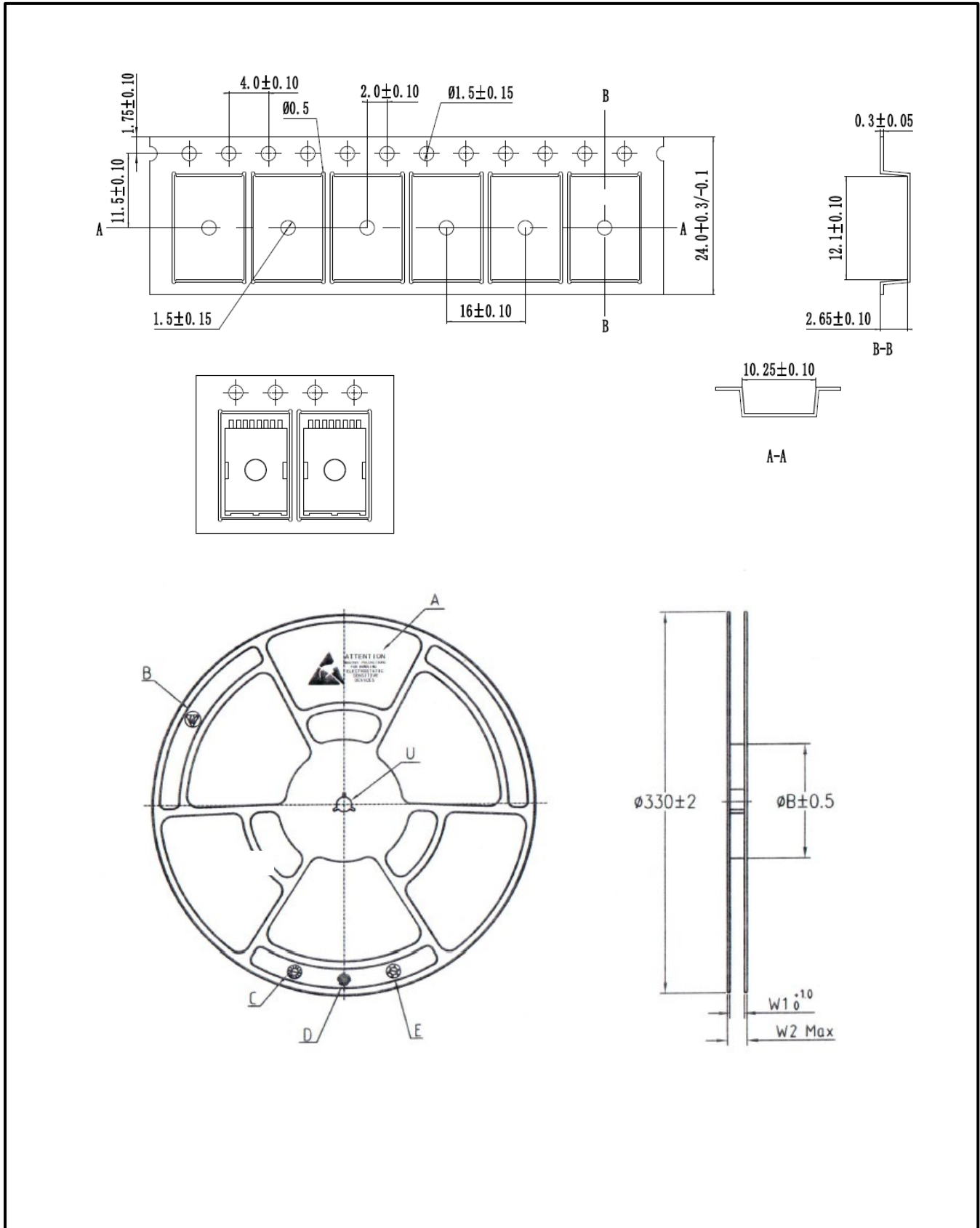


Row	Description	Example
Row1	Company name	INNO
Row2	Product code (In short)	XXXXXXX
Row3	Date code	YYWW
Row4	ASSY lot No.	XXXXXXX

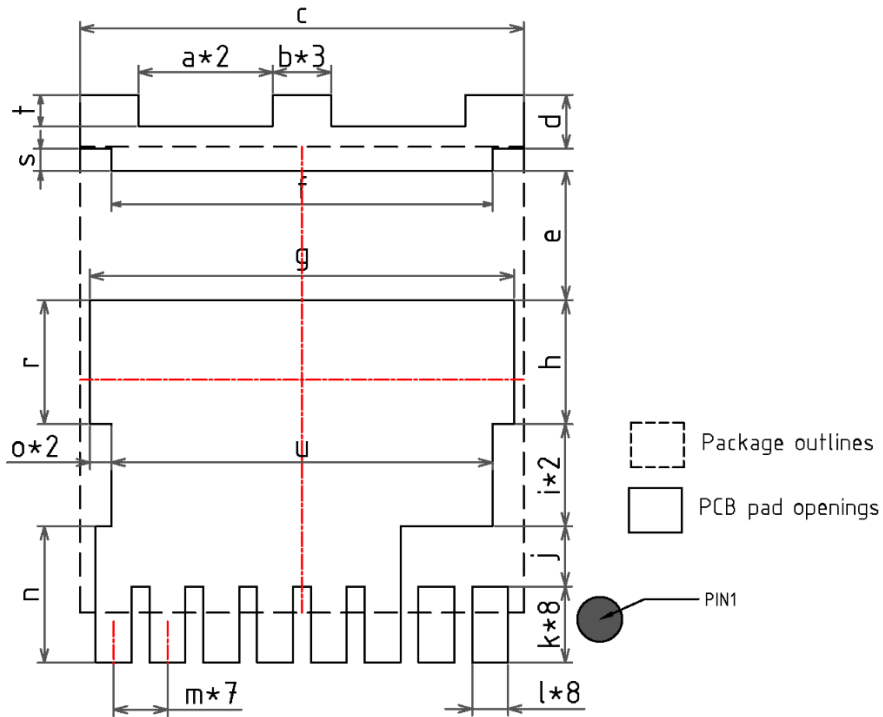
**Notes:**

- (1) Dimensioning and tolerancing confirm to ASME Y14.5M-1994
- (2) All dimensions are in millimeters, angles are in degrees
- (3) Coplanarity applies to the exposed heat slug as well as the terminal
- (4) Radius on terminal is optional
- (5) General tolerance:  $\pm 0.10$  mm

### 11. Reel information



## 12. Recommended PCB footprint



SYMBOL	DIMENSION	SYMBOL	DIMENSION
a	3.00	k	1.70
b	1.30	l	0.80
c	9.90	m	1.20
d	1.20	n	3.05
e	2.88	o	0.48
f	8.50	r	2.77
g	9.46	s	0.50
h	2.77	t	0.70
i	2.28	u	8.50
j	1.35	/	/

Notes:  
 (1) All dimensions are in millimeters.  
 (2) Drawing is not to scale.

## 13. Revision history

### Major changes since the last revision

Revision	Date	Description of changes
1.0	2024-03-14	1.0 version release
1.1	2024-04-12	Update the reel information



---

## Important Notice

The information provided in this document is intended as a guide only and shall not in any event be regarded as a guarantee of conditions, characteristics or performance. Innoscience does not assume any liability arising out of the application or use of any product described herein, including but not limited to any personal injury, death, or property or environmental damage. No licenses, patent rights, or any other intellectual property rights is granted or conveyed. Innoscience reserves the right to modify without notice. All rights reserved.